

RLX 425

Parts Guide



<u>Category</u>	<u>Page Number</u>
Electrical Cabinet	2-3
Motor's, Cable's & Drives	4-5
Switches & Buttons	5-6
Handwheel & Jog Stick	6-7
Pendant & Module	7
Pumps	6
Other Electrical Parts	7-8
Pneumatic & Coolant	9
Main Door & Windows	9-10
Belt's	10
Drag Chain & Wipers	11
Tooling Inc Chucks/Toolpost/ Steady & Drilling Attachment	11-13

Electrical Cabinet

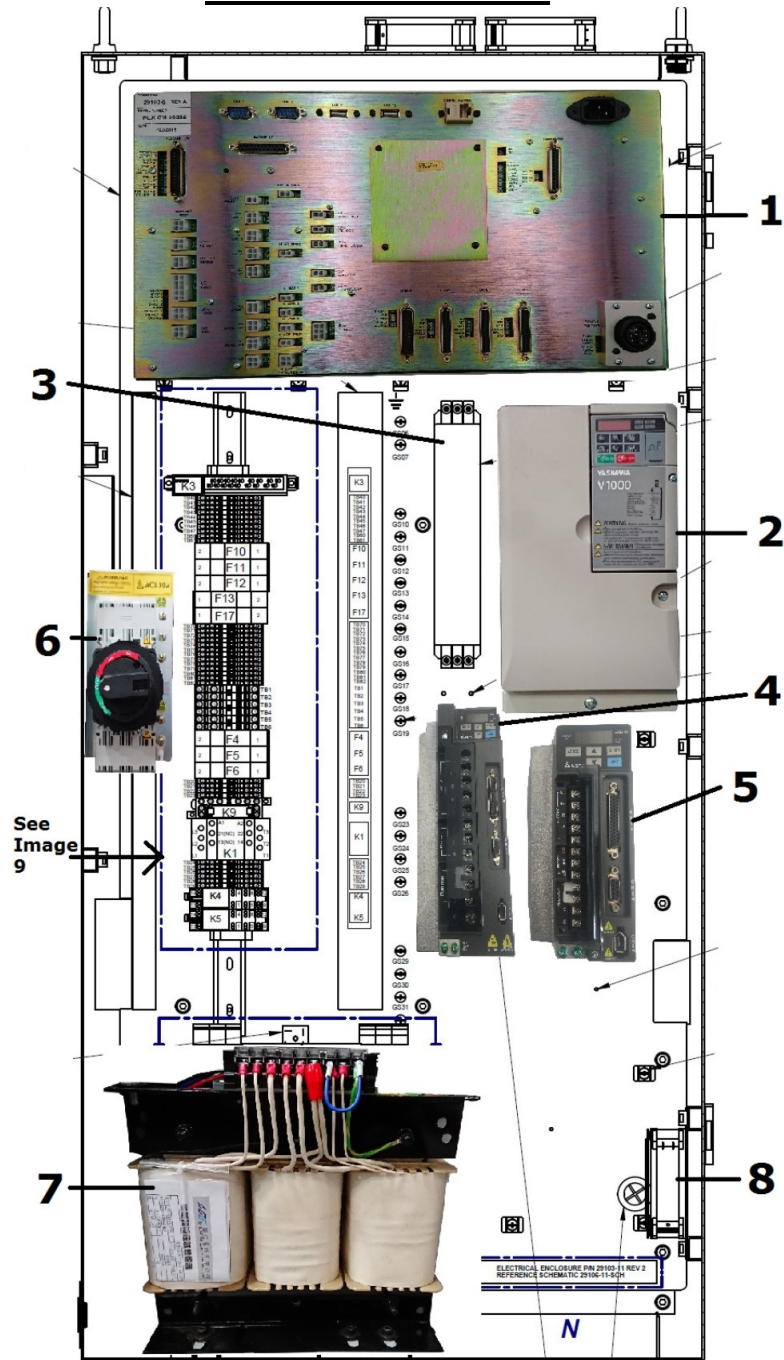

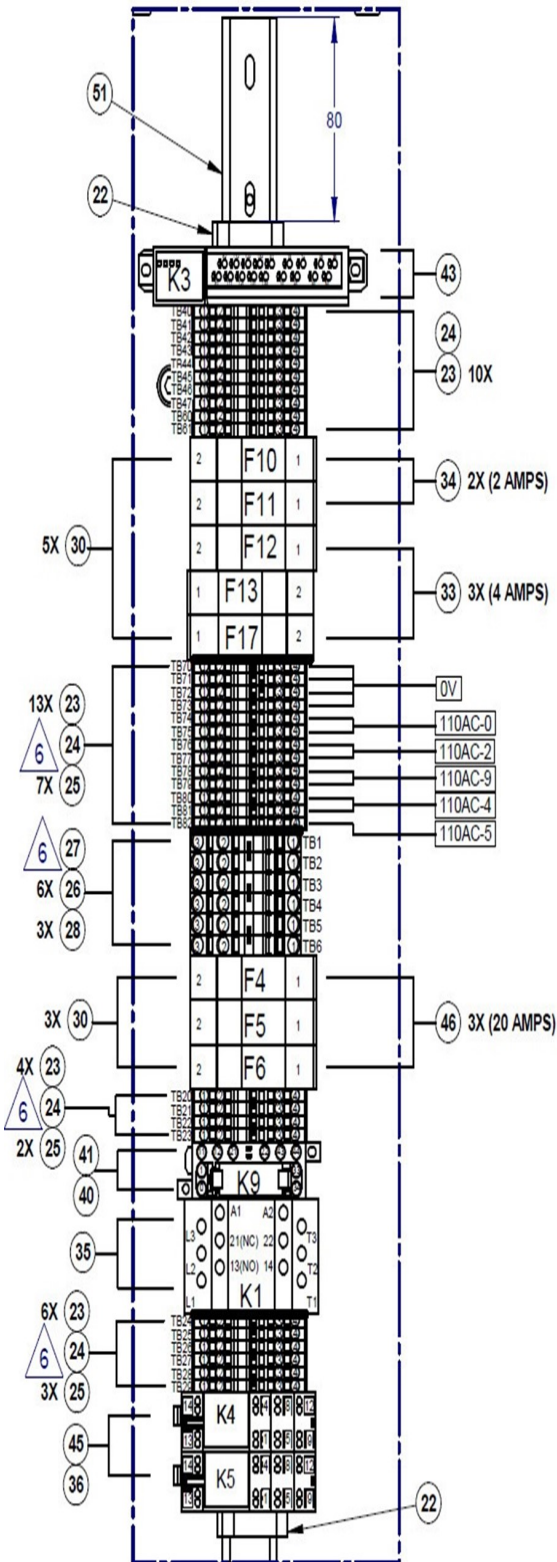

<u>Item Number</u>	<u>Description</u>	<u>XYZ Part Number</u>
1	RLX Computer Module	17404
2	Inverter 7.5 KW	5871
3	Schaffner Line Filter	16782
4	Delta Servo Driver 750W	17611 for 1m or 17621 for 2m
5	Delta Servo Driver 2KW	17612 for 1m or 17622 for 2m
6	Door Isolator Switch 30A	14685
7	Transformer 3 Phase	17231
8	115V Fan	14128

Image 9



<u>Item Number</u>	<u>Description</u>	<u>XYZ Part Number</u>
22	Terminal Block End Cap	10376
23	Terminal Block Din Rail 20A	15168
24	Terminal Block Cover 20A	15167
25	Terminal Block Jumper 20A	15166
26	Terminal Block Din Rail 3 Pos 41A	17699
27	Terminal Block End Cover	17705
28	Terminal Block Jumper 41A	17260
29	Fuse 10 x 38mm 12 Amp	14088
30	Fuse Holder 32A	3750
32	Fuse 10 x 38mm 16 Amp	3147
33	Fuse 10 x 38mm 4 Amp	6622
34	Fuse 10 x 38mm 2 Amp	6616
35	Contactor Relay 24v DC	17337
36	Relay Socket 2 Pole Push Fit	16271
40	Omron Safety Relay	13767
41	Omron Socket Din Rail 4 Pole	13768
43	Omron Safety Relay 401 24V DC	15052
45	Omron Relay 2P 24VDC	16270
46	Fuse 10 x 38mm 20 Amp	6620
51	Din Rail	1655

Motor's, Cable's & Drives

<u>Description</u>	<u>XYZ Part Number</u>	
X Axis Motor	13639	
Z Axis Motor	17647 for 1m 17661 for 2m	
X Axis Drive	17611 for 1m 17612 for 2m	
Z Axis Drive	17621 for 1m 17622 for 2m	
X Axis Motor Encoder Cable	17417	
X Axis Motor Power Cable	17416	
Z Axis Motor Encoder Cable	17186	
Z Axis Motor Power Cable	17418	



Motor's, Cable's & Drives

<u>Description</u>	<u>XYZ Part Number</u>	
Main Spindle Motor	4059	



Switches & Buttons

<u>Description</u>	<u>XYZ Part Number</u>	
E-Stop Button	3132	
Main Door / Belt Inspection Door Switch	3219	
Chuck Guard Switch	3351	
Limit Switch Fits Both X Or Z	16402	
Apron Cycle Start Button	15008	



Switches & Buttons

<u>Description</u>	<u>XYZ Part Number</u>	
Door Isolator Switch	14685	
Gear Selector Sensor Switches	7923	

Pump's

<u>Description</u>	<u>XYZ Part Number</u>	
Coolant Pump 110V 6" Pick Up	1825	
AutoLube Pump 110V YET-F1	10637	
Ishan Headstock Circulation Pump & Motor	3879	

Handwheel's & Jog Stick

<u>Description</u>	<u>XYZ Part Number</u>	
Safety Jog Stick	15012	
X Axis Handwheel	465	



Handwheel's & Jog Stick

<u>Description</u>	<u>XYZ Part Number</u>	
Z Axis Handwheel	6932	

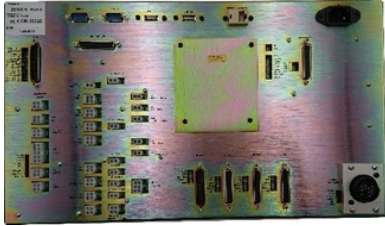
Pendant & Module

<u>Description</u>	<u>XYZ Part Number</u>	
RLX Pendant	17394	
Computer Module	17404	



Other Electrical Parts

<u>Description</u>	<u>XYZ Part Number</u>	
Inverter 7.5KW	5871	
Main Transformer	17231	





Other Electrical Parts

<u>Description</u>	<u>XYZ Part Number</u>	
Brake Resistor	5967 x 3	
Spindle Encoder	17253	
Work Lamp 24V	17367	
Work Light	15823	
Spindle Motor Fan	6439	
Electronic Handwheel & Apron Jog Stick Cable	460 for 1m 570 for 2m	



Filters

<u>Description</u>	<u>XYZ Part Number</u>	
Oil Filter	830	
Door Filter	7920	

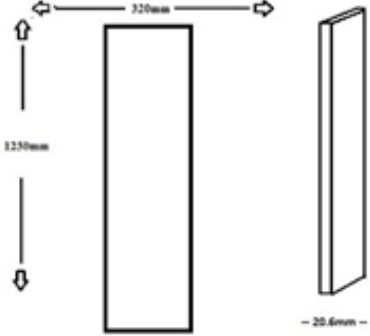

Pneumatic & Coolant

<u>Description</u>	<u>XYZ Part Number</u>	
Air Regulator Unit	4915	
Tailstock Assembly Air Pipe	2196 for 1m 10217 for 2m	
Coolant Nozzle Assembly	12585	
Armoured Coolant Pipe 180" for 1m 220" for 2m	4729 for 1 m 8652 for 2m	





Main Door & Window's

<u>Description</u>	<u>XYZ Part Number</u>	
Door Spring	8346 x 2 for 1m 8345 x 2 for 2m	
Main Window 1504 x 320mm for 1m 2m would be as above & small R.H.S window 603x 280mm	15032 for 1m 15032 for 2m Left hand side 15033 for 2m Right hand side	
Window Silicon	11661	



Pneumatic & Coolant

<u>Description</u>	<u>XYZ Part Number</u>	
Perspex Panel Tailstock End 470 x 375mm	7766	
Perspex Panel Auto Lube Pump	16711	



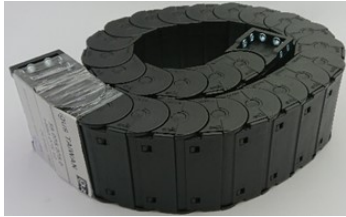

Belt's

<u>Description</u>	<u>XYZ Part Number</u>	
X Axis Belt	778	
Z Axis Belt	17116 for 1m 17421 for 2m	
Spindle Encoder Belt	1897	
Spindle Belt Set	1367	



Drag Chain / Wiper's

<u>Description</u>	<u>XYZ Part Number</u>	
Z Axis Chain	17543 for 1m 17544 for 2m	
Wiper Kit	9795	

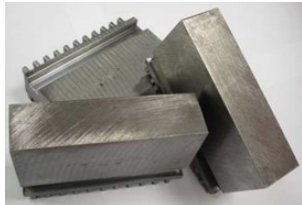

Chuck's

<u>Description</u>	<u>XYZ Part Number</u>	
Standard 250mm Scroll 3 Jaw Chuck Supplied With The Machine	13081	
315mm Independent 4 Jaw Chuck Cast Iron	2611	
Chuck Guard To Suit 250mm Chuck	4807	
Chuck Guard To Suit 315mm Chuck	7311	
Soft Jaws For 250mm 3 Jaw Chuck	2697	

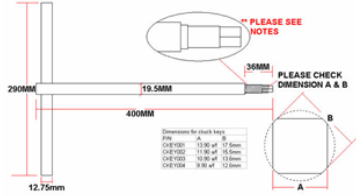
Chuck's

<u>Description</u>	<u>XYZ Part Number</u>																										
Hard Inside Solid Jaws To Suit 250mm 3 Jaw	3058																										
Hard Outside Solid Jaws To Suit 250mm 3 Jaw	3062																										
Soft Jaws For 315mm 4 Jaw Chuck	15841																										
Extended Chuck Key 250 and 315 mm Chuck	4462	 <p>Dimensions for chuck keys</p> <table border="1"> <thead> <tr> <th>Part</th> <th>Material</th> <th>Length</th> <th>Width</th> <th>Height</th> </tr> </thead> <tbody> <tr> <td>CKE-1001</td> <td>12.75</td> <td>400</td> <td>12.75</td> <td>29.5</td> </tr> <tr> <td>CKE-1002</td> <td>12.75</td> <td>400</td> <td>12.75</td> <td>29.5</td> </tr> <tr> <td>CKE-1003</td> <td>12.75</td> <td>400</td> <td>12.75</td> <td>29.5</td> </tr> <tr> <td>CKE-1004</td> <td>12.75</td> <td>400</td> <td>12.75</td> <td>29.5</td> </tr> </tbody> </table>	Part	Material	Length	Width	Height	CKE-1001	12.75	400	12.75	29.5	CKE-1002	12.75	400	12.75	29.5	CKE-1003	12.75	400	12.75	29.5	CKE-1004	12.75	400	12.75	29.5
Part	Material	Length	Width	Height																							
CKE-1001	12.75	400	12.75	29.5																							
CKE-1002	12.75	400	12.75	29.5																							
CKE-1003	12.75	400	12.75	29.5																							
CKE-1004	12.75	400	12.75	29.5																							

Steady Options

<u>Description</u>	<u>XYZ Part Number</u>	
Fixed Steady 20-150mm	4548	
Fixed Steady 15-190mm	4550	
Rock Fixed Steady 15-280mm	14931	

<u>Description</u>	<u>XYZ Part Number</u>	
Travelling Steady 15-70mm	7039	

Tool Post / Holders

<u>Description</u>	<u>XYZ Part Number</u>	
T3 Quick Change Tool Post Set	4928	
T3 Standard Holder	4930	
T3 Vee Holder	4931	
T3 Morse Holder	4932	
T3 Plain Bore 40mm Holder	3870	

Drilling Attachment's

<u>Description</u>	<u>XYZ Part Number</u>	
Drilling Attachment 40mm Bore	7724	